

Date: 08/07/06  
Model #: FCA132418S

1324/18 FRP/PC  
ASSEMBLY

**COVER FEATURES:**

- \* STANDARD LOAD RATING: 20,800 LBS. WHEEL LOAD ON 10" X 20" PLATE
- \* POLYMER CONCRETE CONSTRUCTION
- \* 2 BOLT DOWNS
- \* NON-SKID SURFACE
- \* LIGHTWEIGHT
- \* APPROX. WEIGHT 35 LBS.

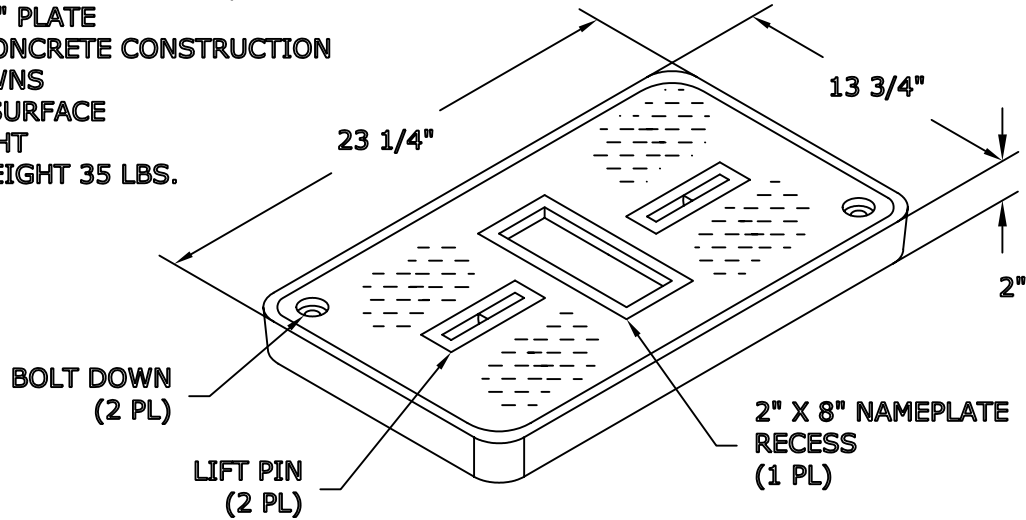

**BOX FEATURES:**

- \* POLYMER CONCRETE RING
- \* FIBER REINFORCED POLYMER BODY
- \* COLOR OF RING = CONCRETE GREY
- \* LIGHTWEIGHT
- \* APPROX. WEIGHT 60 LBS.

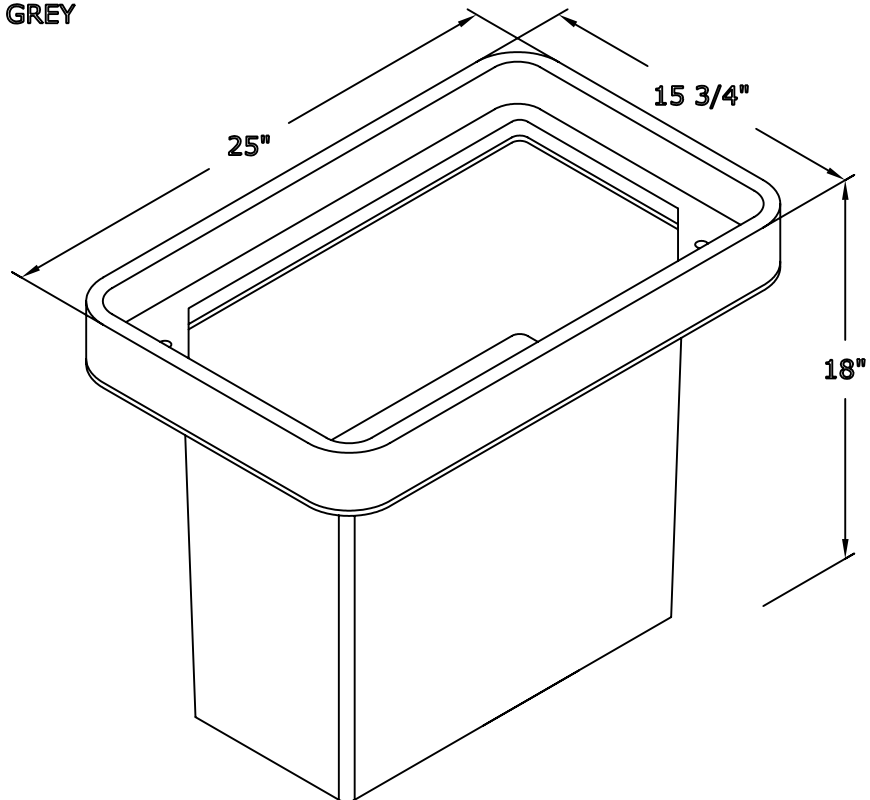

NewBasis  
2626 Kansas Ave.  
Riverside, CA 92507

Phone (951)787-0600  
Fax (951)787-0632  
www.newbasis.com

**newbasis**