

Date: 8/07/06
Model #: FCA243636S

2436/36 FRP/PC
ASSEMBLY

COVER FEATURES:

- * STANDARD LOAD RATING: 20,800 LBS. WHEEL LOAD ON A 10" X 20" PLATE
- * POLYMER CONCRETE CONSTRUCTION
- * 4 BOLT DOWNS (SHOWN) 2 BOLT DOWN AVAILABLE
- * NON-SKID SURFACE
- * APPROX. WEIGHT 118 LBS.

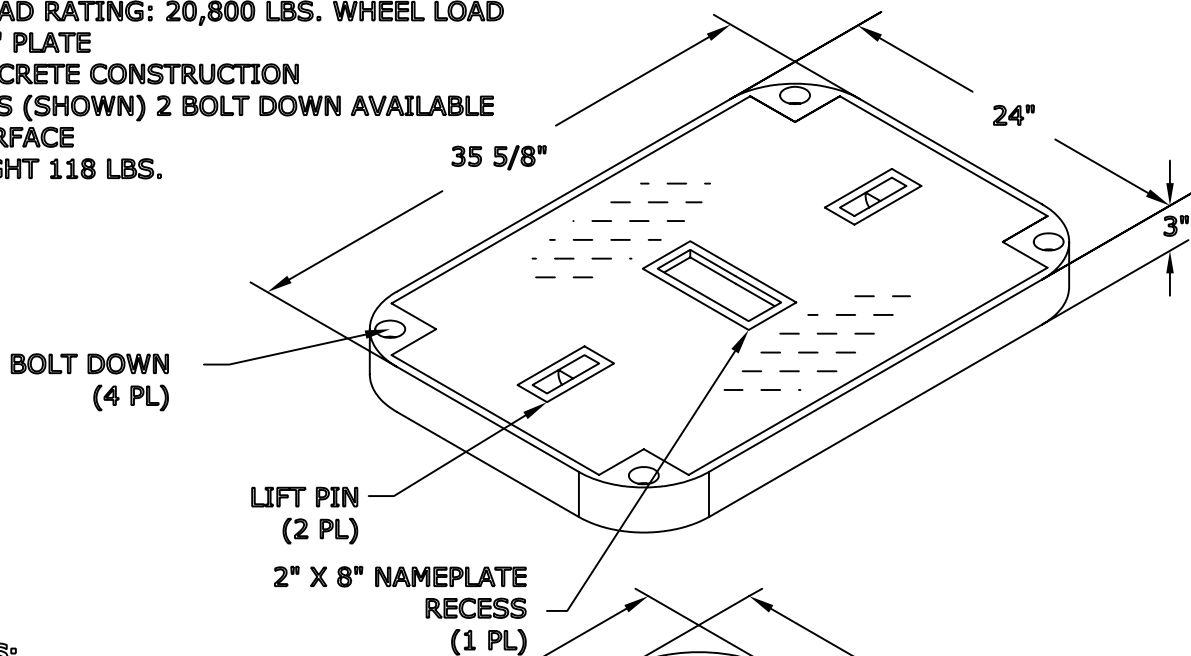

BOX FEATURES:

- * POLYMER CONCRETE RING
- * FIBER REINFORCED POLYMER BODY
- * COLOR OF RING = CONCRETE GREY
- * APPROX. WEIGHT 123 LBS.

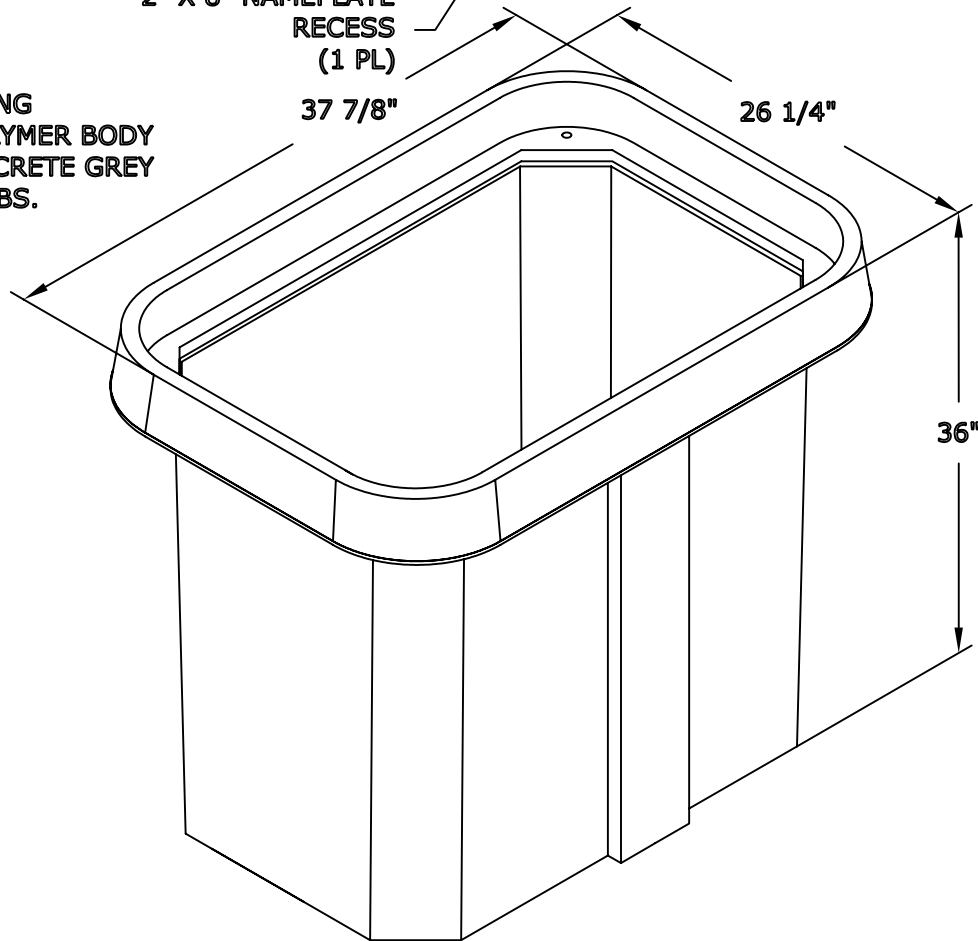

NewBasis
2626 Kansas Ave.
Riverside, CA 92507

Phone (951)787-0600
Fax (951)787-0632
www.newbasis.com

newbasis