

Date: 08/07/06
Model #: FCA366036S

3660/36 FRP/PC
ASSEMBLY

COVER FEATURES:

- * STANDARD LOAD RATING: 20,800 LBS. WHEEL LOAD ON 10" X 20" PLATE
- * 4 BOLT DOWN LOCATIONS
- * POLYMER CONCRETE CONSTRUCTION
- * NON-SKID SURFACE STANDARD
- * APPROX. WEIGHT 190 LBS. (EACH HALF)

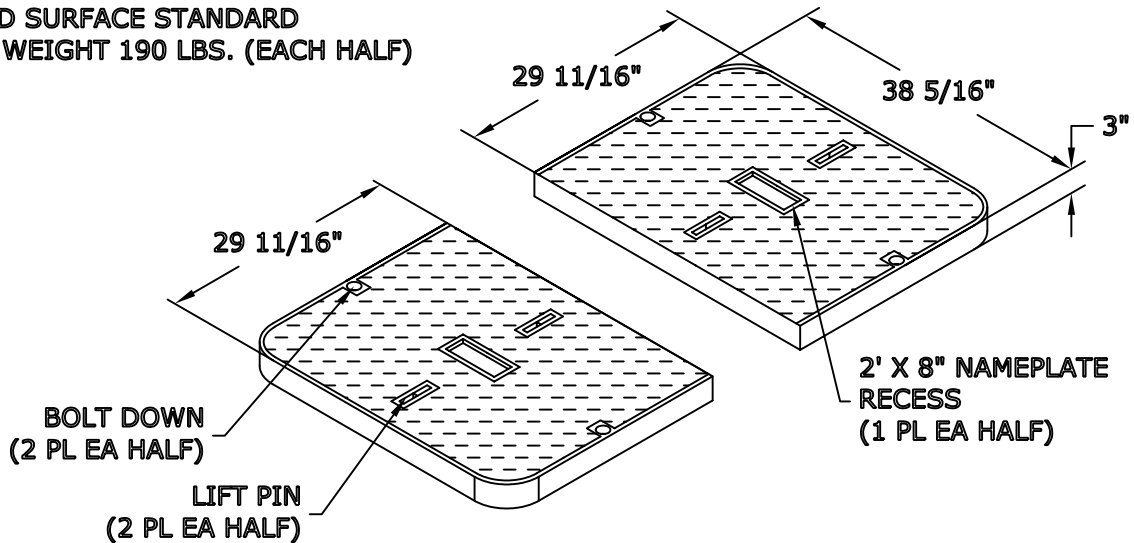

BOX FEATURES:

- * POLYMER CONCRETE RING
- * FIBER REINFORCED POLYMER BODY
- * APPROX. WEIGHT 222 LBS.

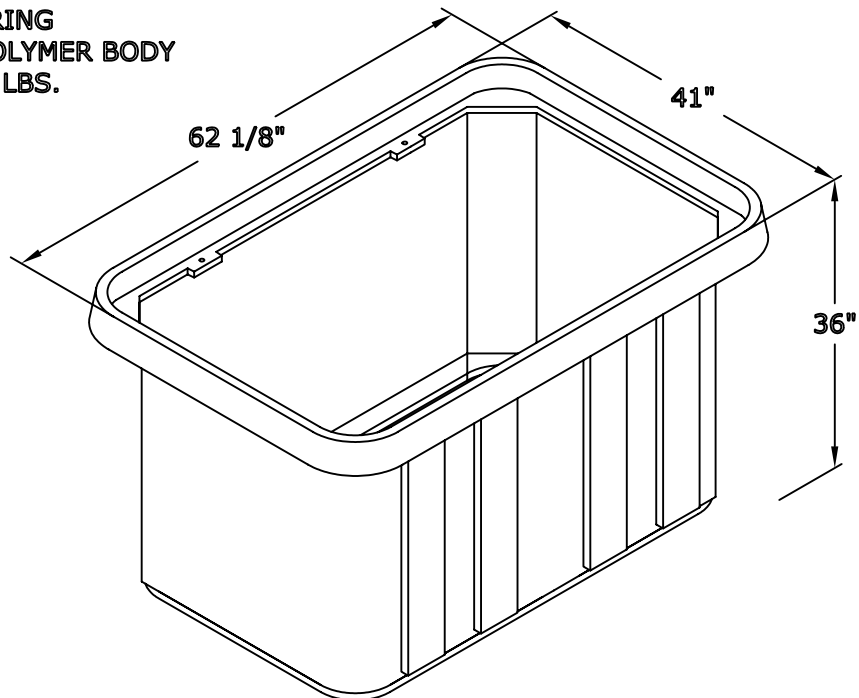

NewBasis
2626 Kansas Ave.
Riverside, CA 92507

Phone (951)787-0600
Fax (951)787-0632
www.newbasis.com

newbasis