

Date: 08/07/06
Model #: PCA173012S

1730/12 POLYMER CONCRETE ASSEMBLY

COVER FEATURES:

- * STANDARD LOAD RATING: 20,800 LBS. WHEEL LOAD ON 10" X 20" PLATE
- * 2 BOLT DOWN LOCATIONS
- * POLYMER CONCRETE CONSTRUCTION
- * NON-SKID SURFACE STANDARD
- * APPROXIMATE WEIGHT = 57 LBS.

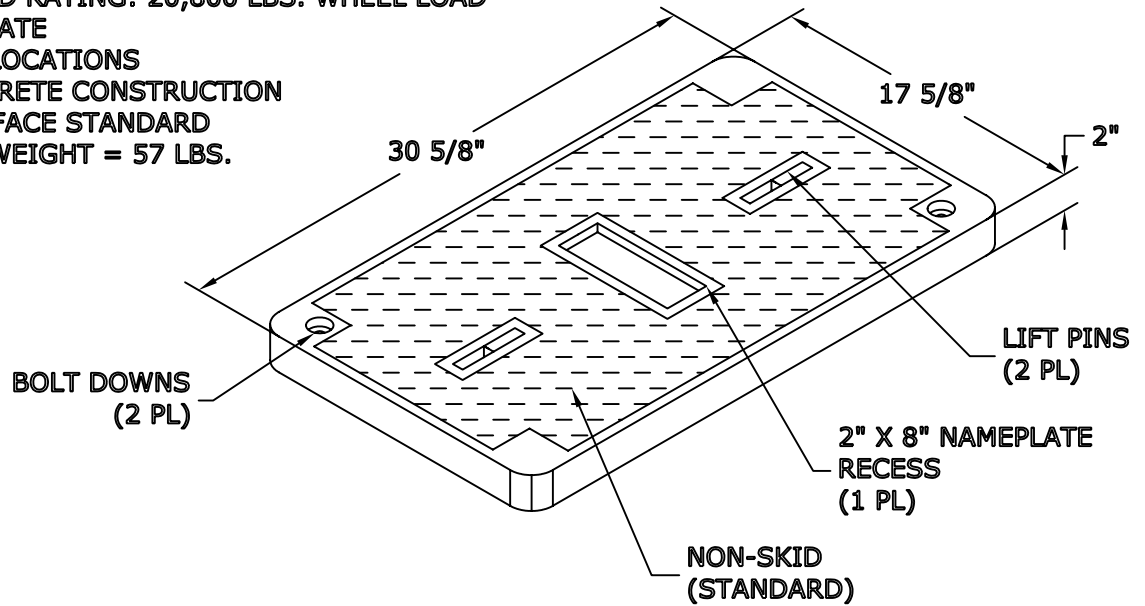

BOX FEATURES:

- * POLYMER CONCRETE CONSTRUCTION
- * APPROX. WEIGHT 80 LBS.

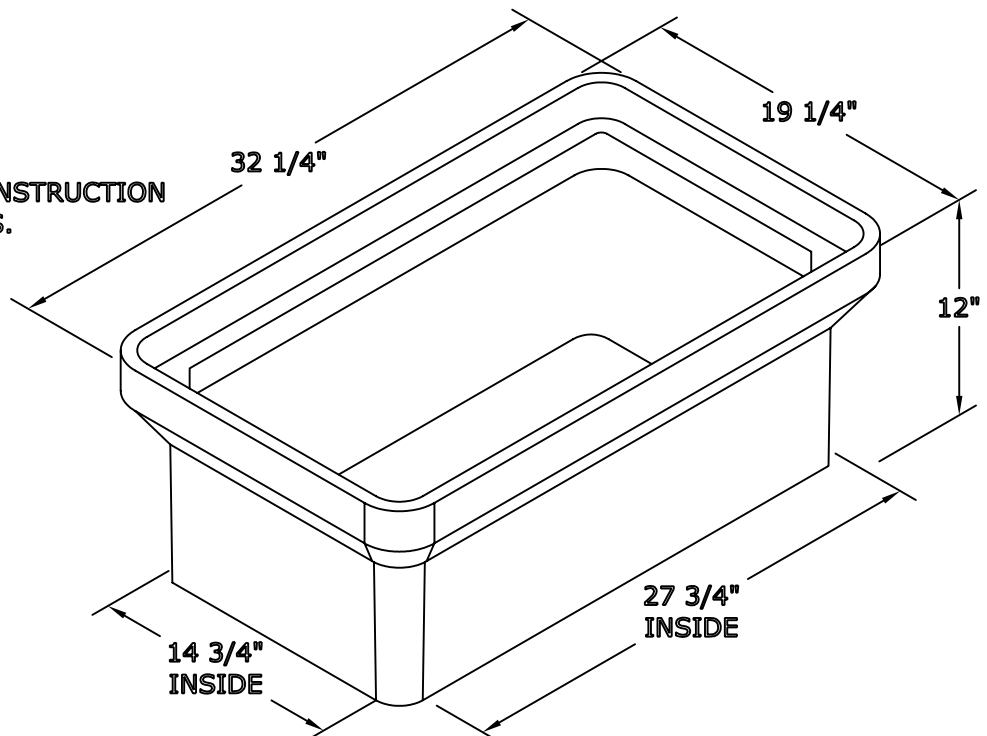

NewBasis
2626 Kansas Ave.
Riverside, CA 92507

Phone (951)787-0600
Fax (951)787-0632
www.newbasis.com

newbasis