

Date: 8/07/06
Model #: PCA304824S

3048/24 ASSEMBLY
ALL POLYMER CONCRETE

COVER FEATURES:

- * STANDARD LOAD RATING: 20,800 POUND WHEEL LOAD ON 10 X 20 PLATE
- * POLYMER CONCRETE CONSTRUCTION
- * WEIGHT = 110 POUNDS (EACH HALF)
- * 4 BOLT DOWN LOCATIONS
- * COLOR = CONCRETE GREY
- * NON-SKID SURFACE

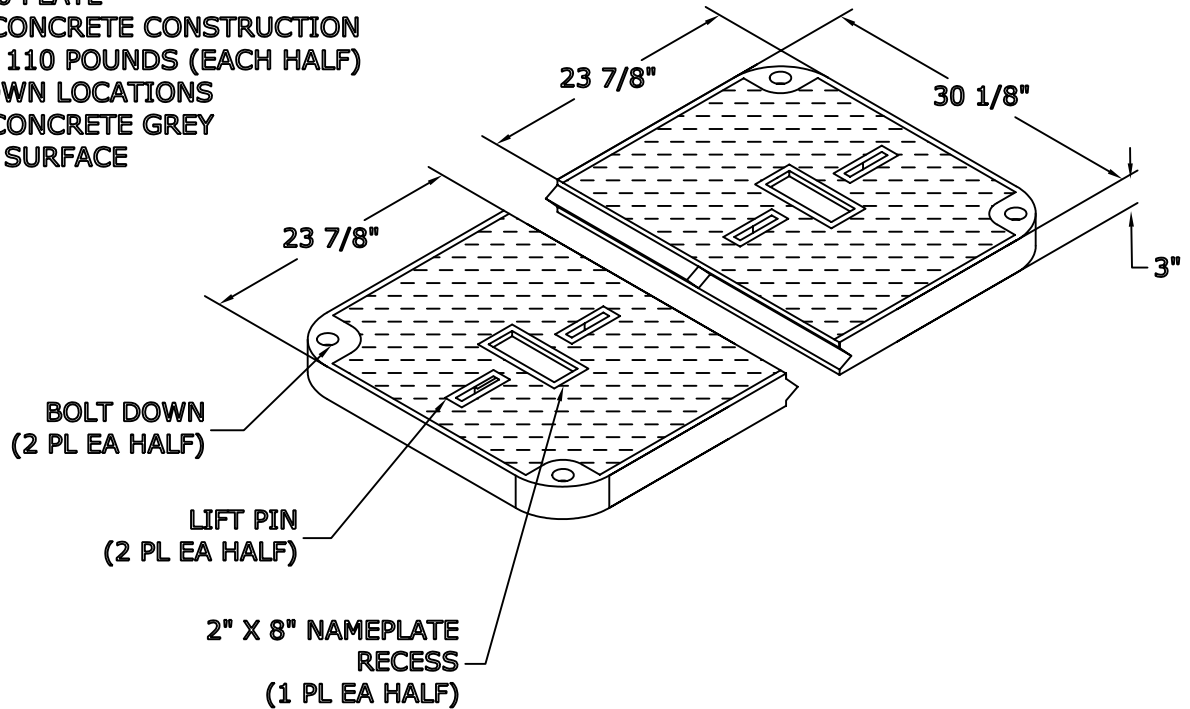

BOX FEATURES:

- * POLYMER CONCRETE CONSTRUCTION
- * STACKABLE
- * APPROX. WEIGHT 385 LBS.

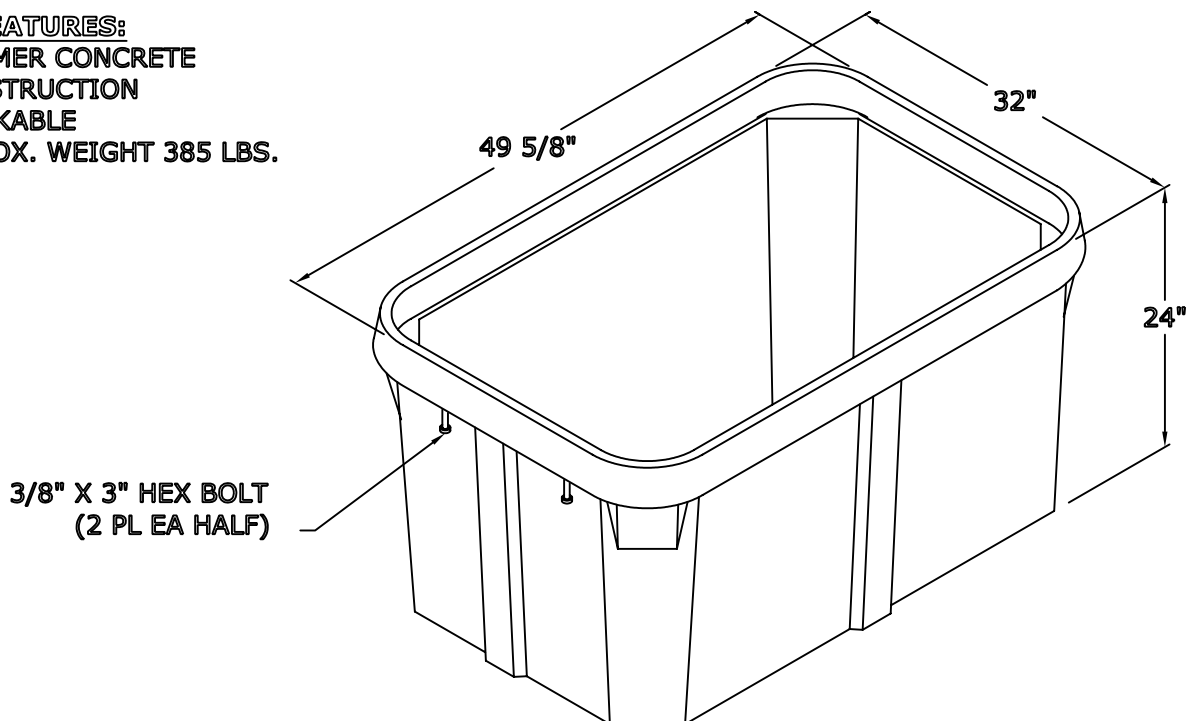

NewBasis
2626 Kansas Ave.
Riverside, CA 92507

Phone (951)787-0600
Fax (951)787-0632
www.newbasis.com

newbasis